

MITSUBISHI HVIGBT MODULES
CM1800HC-34H

3rd-Version HVIGBT (High Voltage Insulated Gate Bipolar Transistor) Modules

HIGH POWER SWITCHING USE
 INSULATED TYPE

CM1800HC-34H



- Ic 1800A
- VCES 1700V
- Insulated Type
- 1-element in a Pack
- AISiC Baseplate
- Soft Reverse Recovery Diode

APPLICATION

Traction drives, High Reliability Converters / Inverters, DC choppers

OUTLINE DRAWING & CIRCUIT DIAGRAM

Dimensions in mm

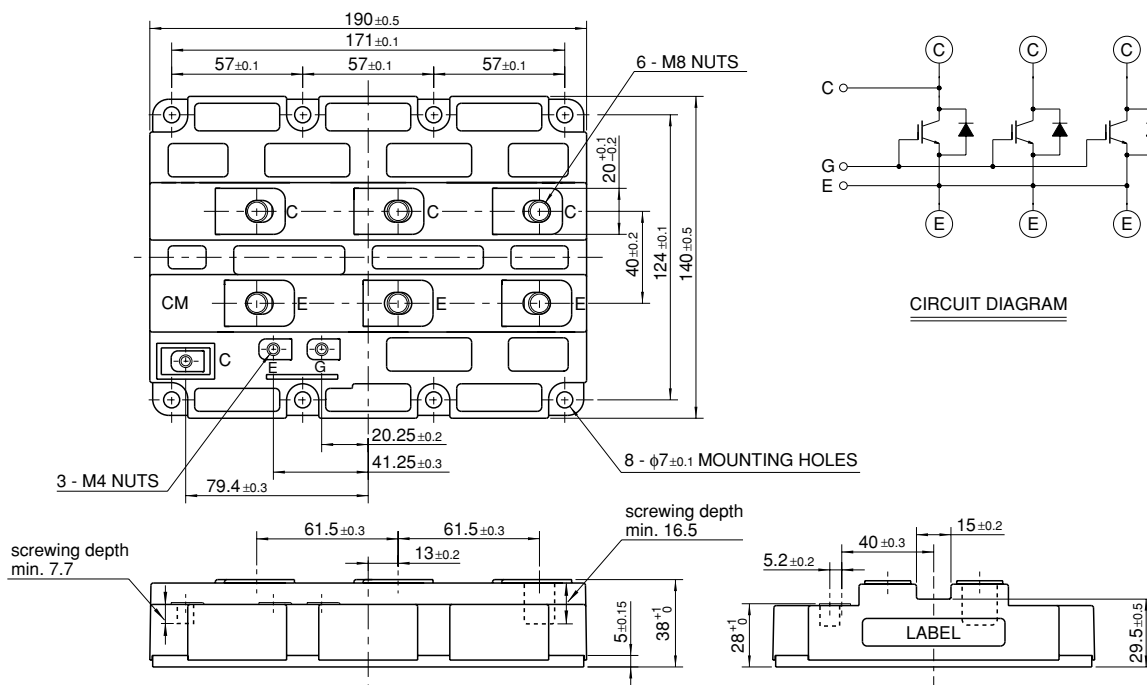

HVIGBT (High Voltage Insulated Gate Bipolar Transistor) Modules

Jul. 2005

CM1800HC-34H

**HIGH POWER SWITCHING USE
INSULATED TYPE**

3rd-Version HVIGBT (High Voltage Insulated Gate Bipolar Transistor) Modules

MAXIMUM RATINGS

Symbol	Item	Conditions	Ratings	Unit
V _{CE} S	Collector-emitter voltage	V _{GE} = 0V, T _j = 25°C	1700	V
V _{GE} S	Gate-emitter voltage	V _{CE} = 0V, T _j = 25°C	±20	V
I _C	Collector current	T _C = 85°C	1800	A
I _{CM}		Pulse (Note 1)	3600	A
I _E (Note 2)	Emitter current		1800	A
I _{EM} (Note 2)		Pulse (Note 1)	3600	A
P _C (Note 3)	Maximum power dissipation	T _C = 25°C, IGBT part	15600	W
T _j	Junction temperature		-40 ~ +150	°C
T _{op}	Operating temperature		-40 ~ +125	°C
T _{stg}	Storage temperature		-40 ~ +125	°C
V _{iso}	Isolation voltage	RMS, sinusoidal, f = 60Hz, t = 1min.	4000	V
t _p sc	Maximum short circuit pulse width	V _{CC} = 1150V, V _{CE} ≤ 1700V, V _{GE} = 15V T _j = 125°C	10	μs

ELECTRICAL CHARACTERISTICS

Symbol	Item	Conditions	Limits			Unit
			Min	Typ	Max	
I _{CE} S	Collector cut-off current	V _{CE} = V _{CE} S, V _{GE} = 0V, T _j = 25°C	—	—	28	mA
V _{GE(th)}	Gate-emitter threshold voltage	I _C = 180mA, V _{CE} = 10V, T _j = 25°C	4.5	5.5	6.5	V
I _{GE} S	Gate leakage current	V _{GE} = V _{GE} S, V _{CE} = 0V, T _j = 25°C	—	—	0.5	μA
V _{CE(sat)}	Collector-emitter saturation voltage	I _C = 1800A, V _{GE} = 15V, T _j = 25°C (Note 4)	—	2.40	3.10	V
		I _C = 1800A, V _{GE} = 15V, T _j = 125°C (Note 4)	—	2.85	—	
C _{ies}	Input capacitance	V _{CE} = 10V, f = 100kHz V _{GE} = 0V, T _j = 25°C	—	187	—	nF
C _{oes}	Output capacitance		—	26.7	—	nF
C _{res}	Reverse transfer capacitance		—	10.1	—	nF
Q _g	Total gate charge	V _{CC} = 850V, I _C = 1800A, V _{GE} = 15V, T _j = 25°C	—	17.6	—	μC
V _{EC} (Note 2)	Emitter-collector voltage	I _E = 1800A, V _{GE} = 0V, T _j = 25°C (Note 4)	—	2.20	2.80	V
		I _E = 1800A, V _{GE} = 0V, T _j = 125°C (Note 4)	—	1.70	—	
t _{d(on)}	Turn-on delay time	V _{CC} = 850V, I _C = 1800A, V _{GE} = ±15V R _{G(on)} = 0.3Ω, T _j = 125°C, L _s = 80nH	—	—	1.60	μs
t _r	Turn-on rise time		—	—	1.30	μs
E _{on}	Turn-on switching energy	Inductive load	—	590	—	mJ/pulse
t _{d(off)}	Turn-off delay time	V _{CC} = 850V, I _C = 1800A, V _{GE} = ±15V R _{G(off)} = 0.3Ω, T _j = 125°C, L _s = 80nH	—	—	2.70	μs
t _f	Turn-off fall time		—	—	0.80	μs
E _{off}	Turn-off switching energy	Inductive load	—	670	—	mJ/pulse
t _{rr} (Note 2)	Reverse recovery time	V _{CC} = 850V, I _C = 1800A, V _{GE} = ±15V	—	—	2.70	μs
Q _{rr} (Note 2)	Reverse recovery charge	R _{G(on)} = 0.3Ω, T _j = 125°C, L _s = 80nH	—	560	—	μC
E _{rec} (Note 2)	Reverse recovery energy	Inductive load	—	260	—	mJ/pulse

- Note 1. Pulse width and repetition rate should be such that junction temperature (T_j) does not exceed T_{opmax} rating (125°C).
 2. The symbols represent characteristics of the anti-parallel, emitter to collector free-wheel diode (FWDi).
 3. Junction temperature (T_j) should not exceed T_{jmax} rating (150°C).
 4. Pulse width and repetition rate should be such as to cause negligible temperature rise.

CM1800HC-34H

**HIGH POWER SWITCHING USE
INSULATED TYPE**

3rd-Version HVIGBT (High Voltage Insulated Gate Bipolar Transistor) Modules

THERMAL CHARACTERISTICS

Symbol	Item	Conditions	Limits			Unit
			Min	Typ	Max	
R _{th(j-c)Q}	Thermal resistance	Junction to Case, IGBT part	—	—	8.0	K/kW
R _{th(j-c)R}		Junction to Case, FWDi part	—	—	13.0	K/kW
R _{th(c-f)}	Contact thermal resistance	Case to Fin, $\lambda_{grease} = 1W/m \cdot K$	—	7.0	—	K/kW

MECHANICAL CHARACTERISTICS

Symbol	Item	Conditions	Limits			Unit
			Min	Typ	Max	
M	Mounting torque	M8 : Main terminals screw	7.0	—	13.0	N·m
		M6 : Mounting screw	3.0	—	6.0	
		M4 : Auxiliary terminals screw	1.0	—	2.0	
—	Mass		—	1.5	—	kg
CTI	Comparative tracking index		600	—	—	—
d _a	Clearance distance in air		19.5	—	—	mm
d _s	Creepage distance along surface		32.0	—	—	mm
LC-E(int)	Internal inductance	IGBT part	—	10	—	nH

CM1800HC-34H

HIGH POWER SWITCHING USE
INSULATED TYPE

3rd-Version HVIGBT (High Voltage Insulated Gate Bipolar Transistor) Modules

PERFORMANCE CURVES

OUTPUT CHARACTERISTICS (TYPICAL)

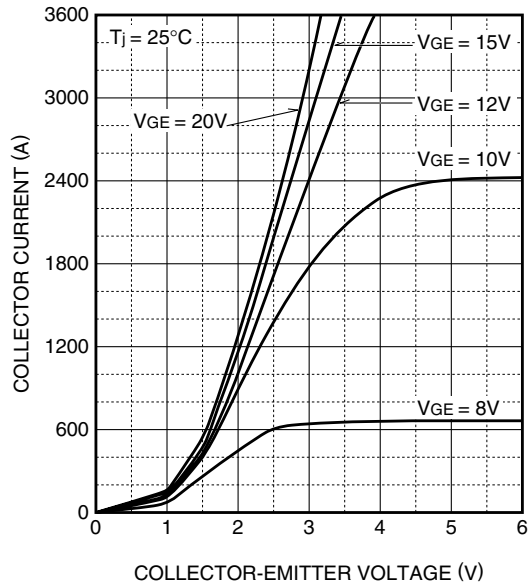

TRANSFER CHARACTERISTICS (TYPICAL)

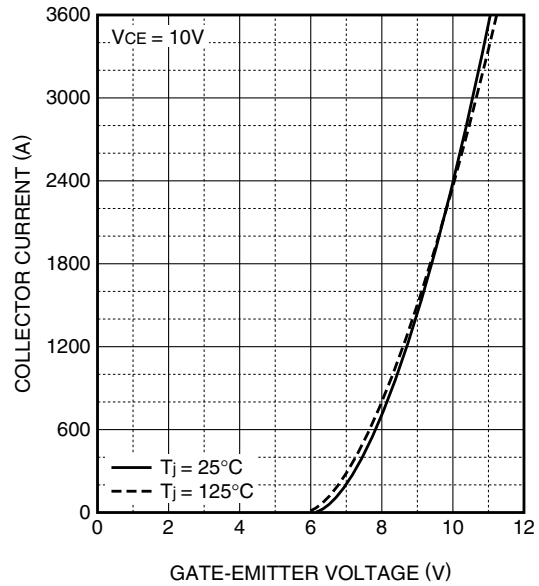

COLLECTOR-EMITTER SATURATION VOLTAGE CHARACTERISTICS (TYPICAL)

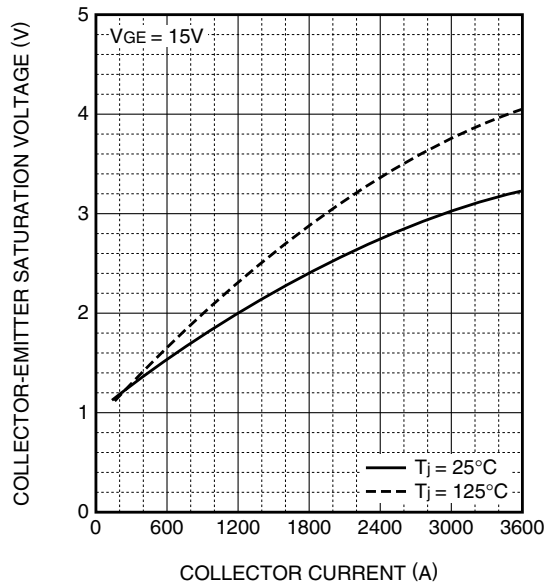

FREE-WHEEL DIODE FORWARD CHARACTERISTICS (TYPICAL)

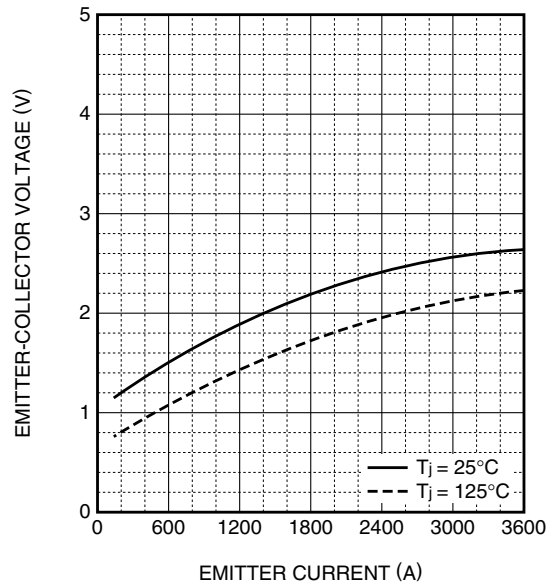

CM1800HC-34H

HIGH POWER SWITCHING USE
INSULATED TYPE

3rd-Version HVIGBT (High Voltage Insulated Gate Bipolar Transistor) Modules

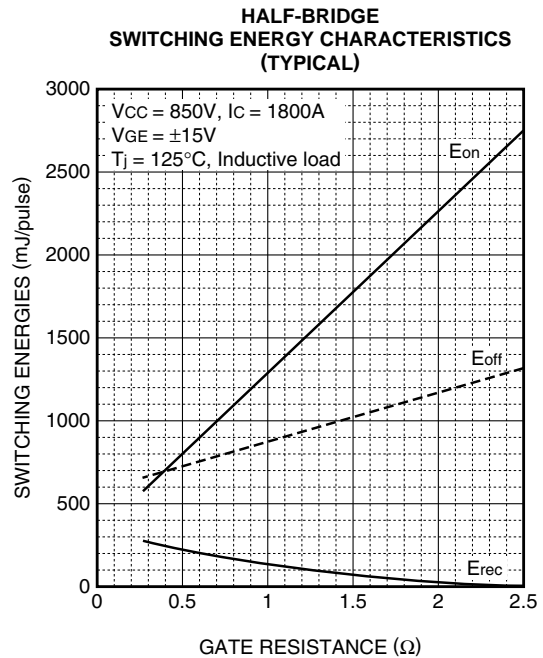
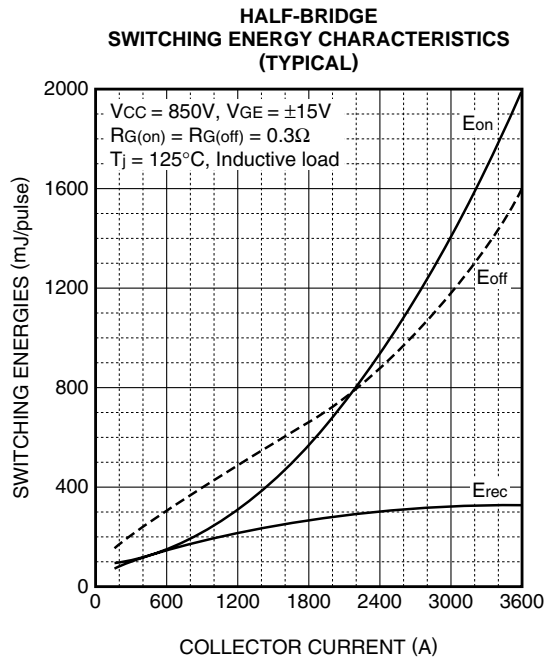
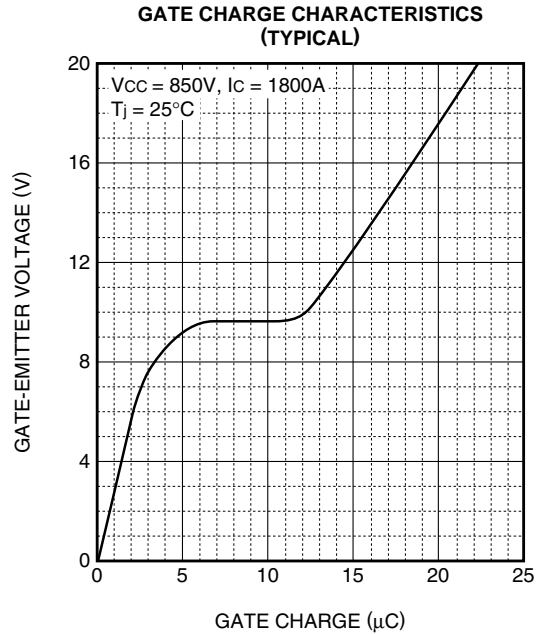
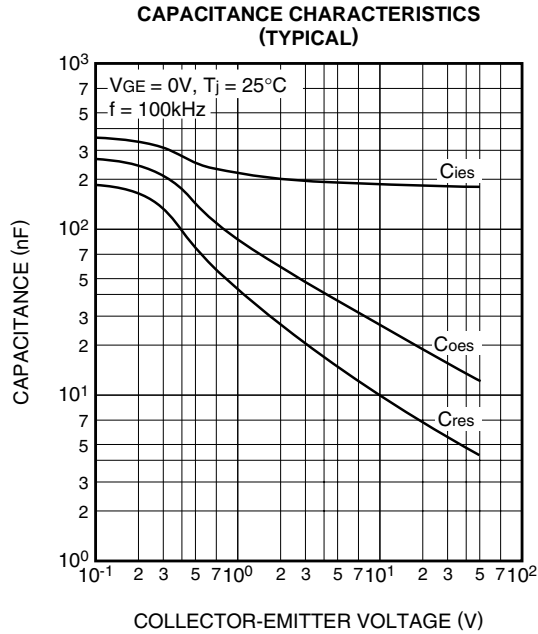

CM1800HC-34H

**HIGH POWER SWITCHING USE
INSULATED TYPE**

3rd-Version HVIGBT (High Voltage Insulated Gate Bipolar Transistor) Modules

**HALF-BRIDGE
SWITCHING TIME CHARACTERISTICS
(TYPICAL)**

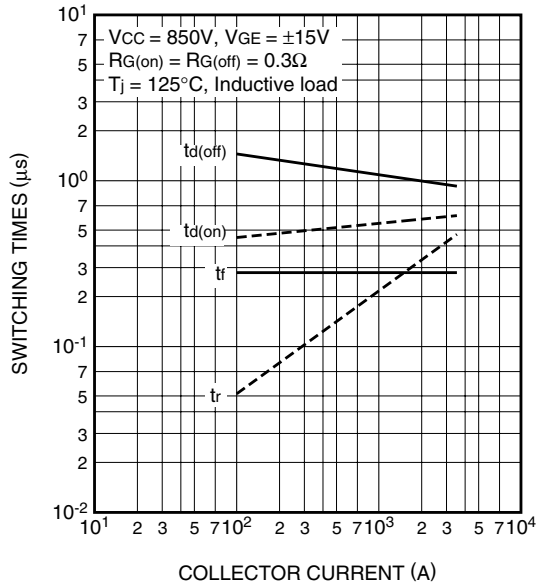

**FREE-WHEEL DIODE
REVERSE RECOVERY CHARACTERISTICS
(TYPICAL)**

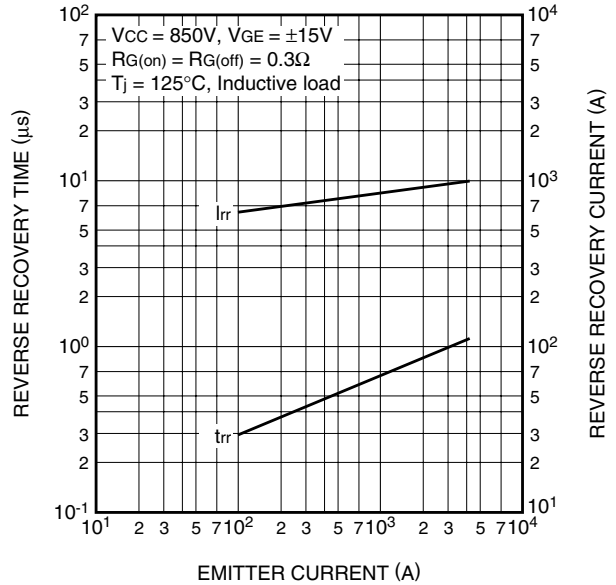

**TRANSIENT THERMAL
IMPEDANCE CHARACTERISTICS**

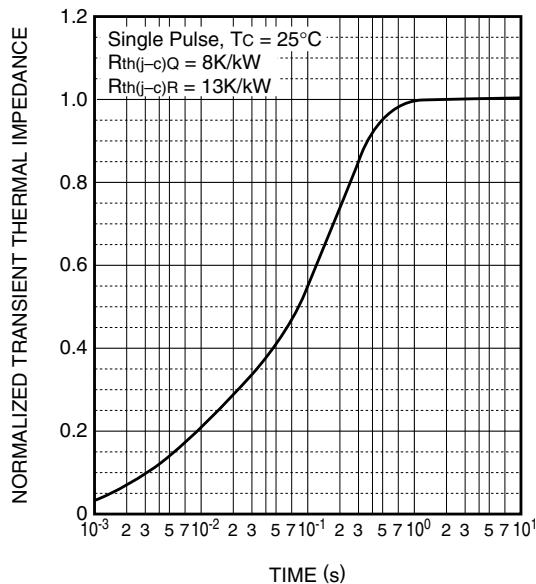

**REVERSE BIAS SAFE OPERATING AREA
(RBSOA)**

